



ART. 6017  
SINGLE



ART. 6023  
DOUBLE



 Single or double sided aluminum brochure stand with 4 mm acrylic transparent shelves for 8 or 16 pcs. of A4 brochures.

 Ein- oder doppelseitiger Aluminium Ständer. Fächer aus 4 mm Acryl für 8 oder 16 Stück A4 Prospekte.

 Enkelt- eller dobbeltsidet aluminiums brochurestander med 4 mm akrylhylder til 8 eller 16 stk. A4-brochurer.

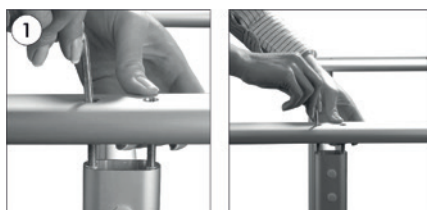
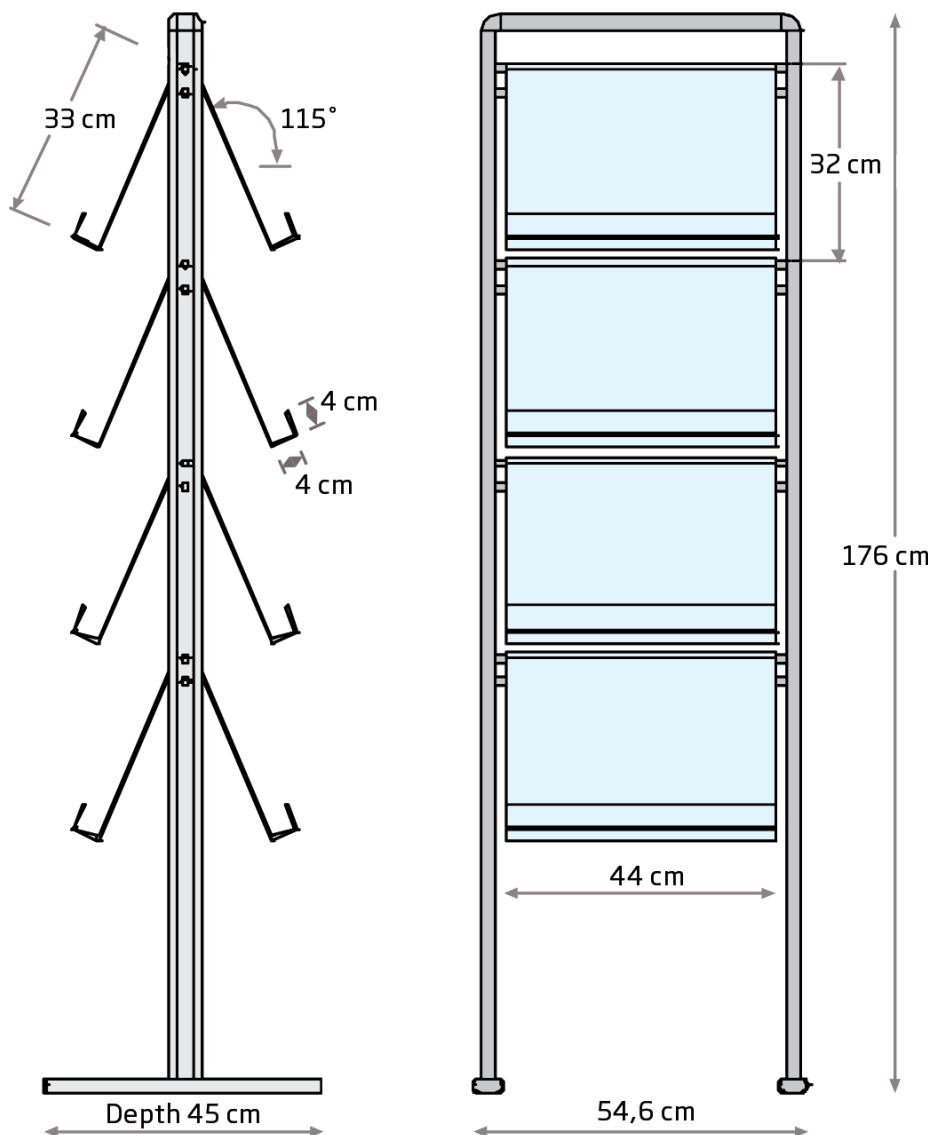

• Fix the bottom feet to the legs on both sides by allen key.  
• Fixieren Sie die Fussprofile an die Seitenprofile fest.

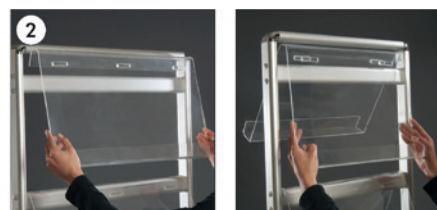

• Place the acrylic shelves from bottom to top.  
• Beginnend von unten sind die Acrylablagen an Querstreben anzuhängen.

PROFILE

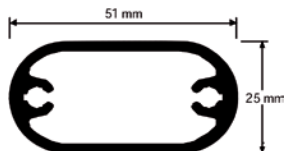

Model	Art.no.	Capacity	Colour	Total W x H	Package size and weight	Pallet size and quantity
819	6017	8 x A4 Single	Alu / acrylic	54,6 x 176 cm	56 x 178 x 7 cm 12 kg	80 x 120 x 220 cm 12 pcs.
-	6023	16 x A4 Double	-	54,6 x 176 cm	56 x 178 x 8 cm 16 kg	80 x 120 x 220 cm 15 pcs.